

MMANA-GAL basic v. 3.0.0.31

5ele 20m (35mm/30mm/25mm Pipe)

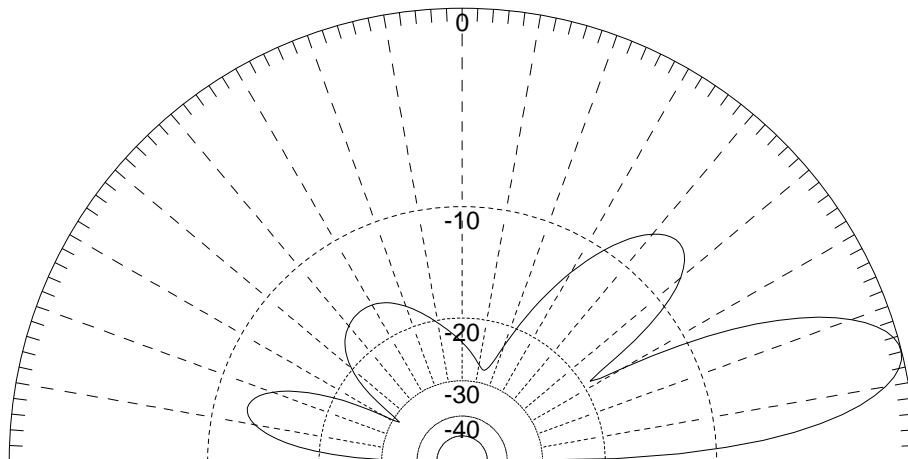
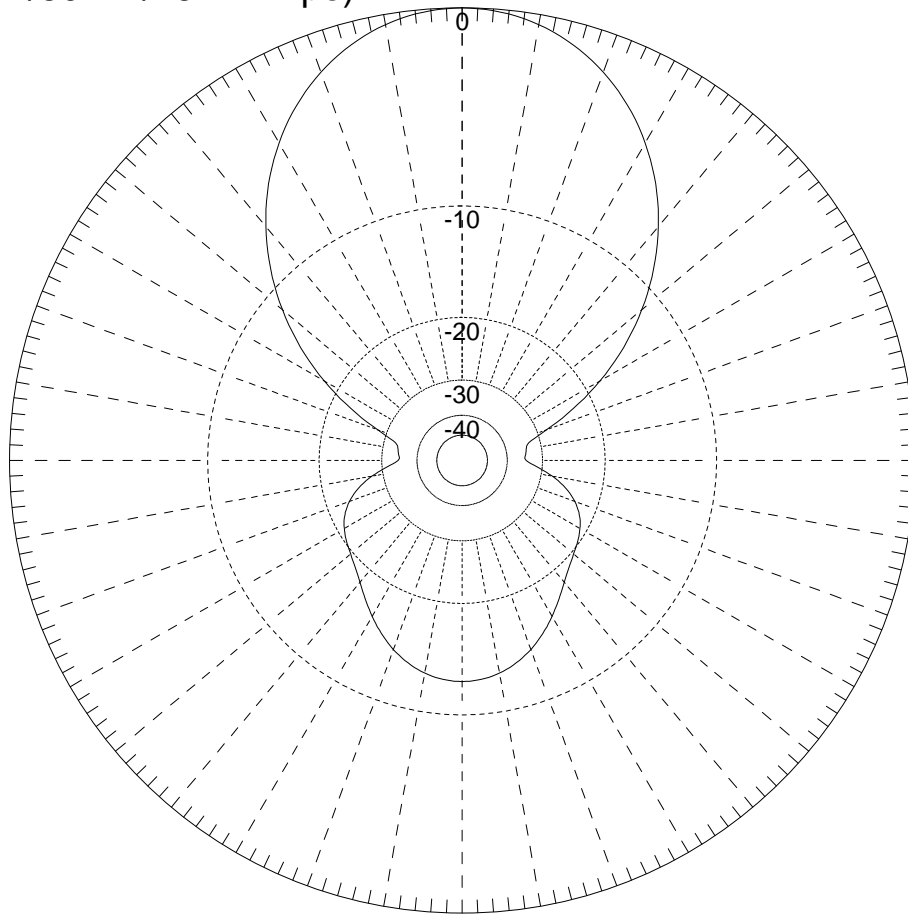

Ga : 14.7 dBi = 0 dB (Horizontal polarization)
F/B: 12.43 dB; Rear: Azim. 120 deg, Elev. 30 deg
Freq: 28.200 MHz
Z: 53.106 - j15.941 Ohm
SWR: 1.4 (50.0 Ohm),
Elev: 14.2 deg (Real GND :10.00 m height)