

MMANA-GAL basic v. 3.0.0.31

5ele 20m (35mm/30mm/25mm Pipe)

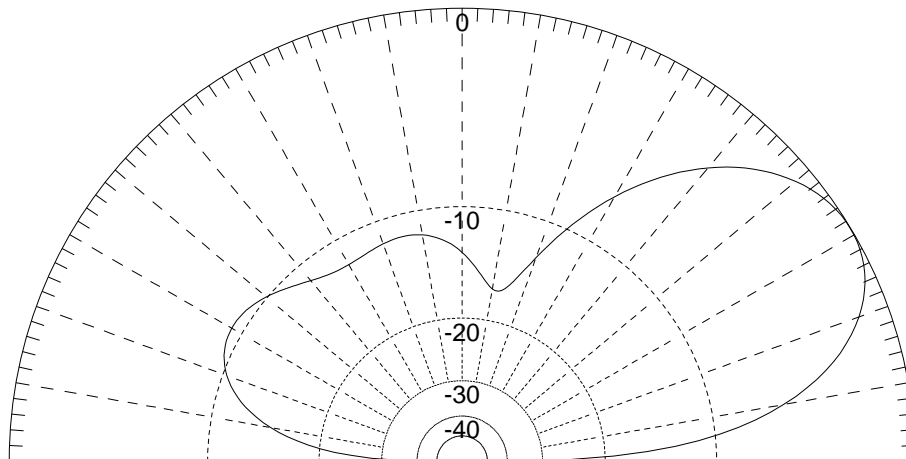
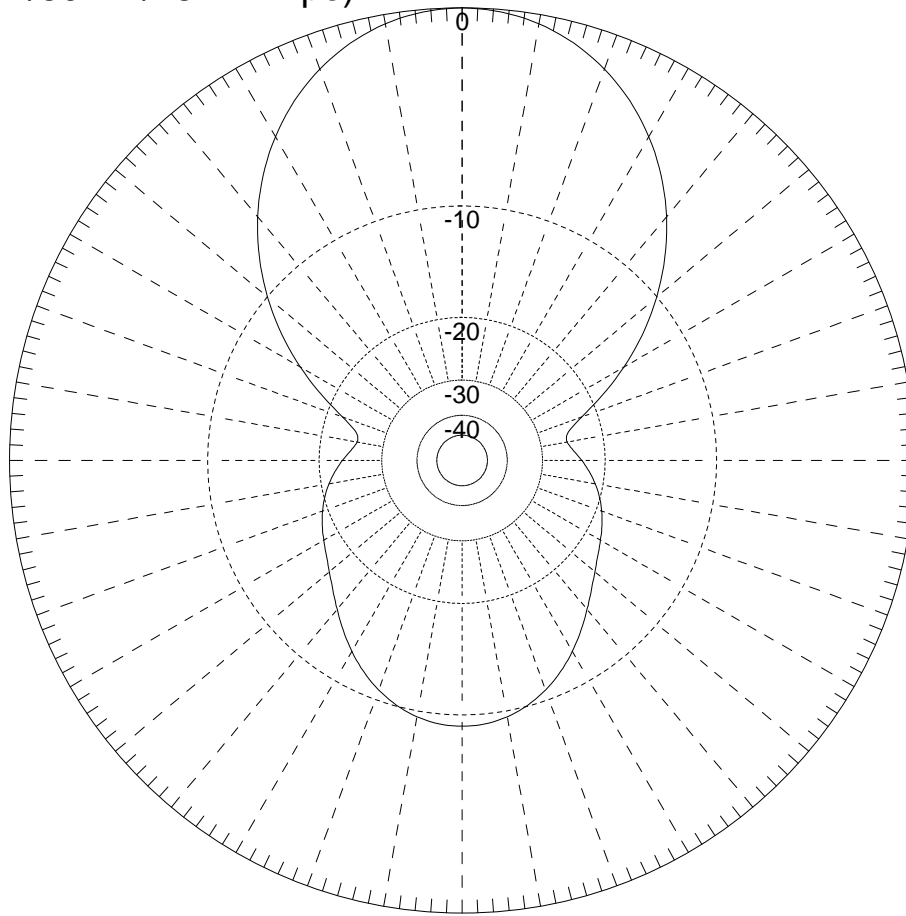

Ga : 11.58 dBi = 0 dB (Horizontal polarization)  
F/B: 9.23 dB; Rear: Azim. 120 deg, Elev. 30 deg  
Freq: 28.200 MHz  
Z: 68.479 - j8.605 Ohm  
SWR: 1.4 (50.0 Ohm),  
Elev: 30.9 deg (Real GND :3.00 m height)