

MMANA-GAL basic v. 3.0.0.31

5ele 20m (35mm/30mm/25mm Pipe)

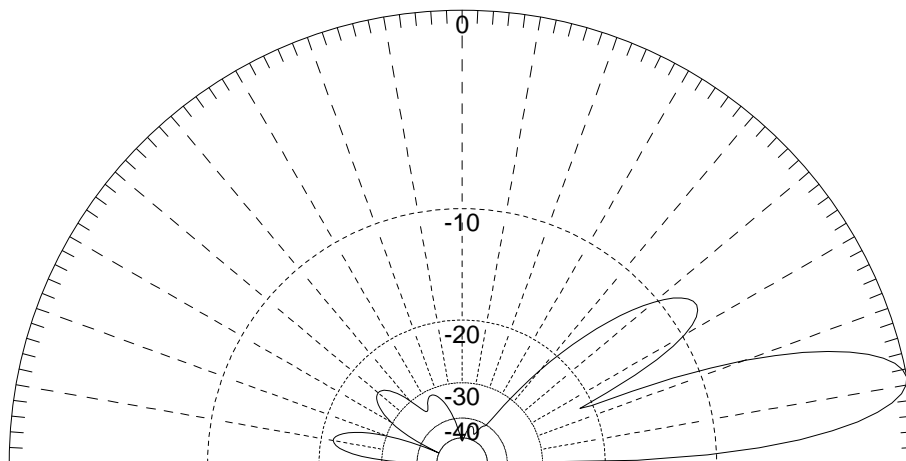
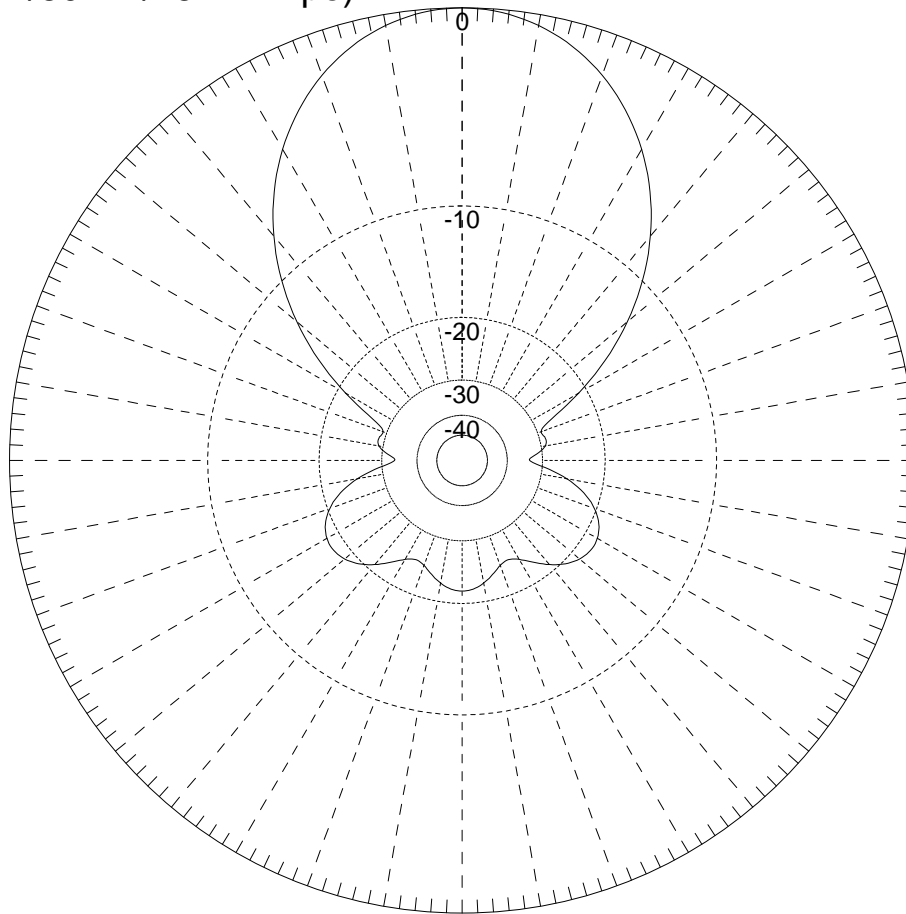

Ga : 16.72 dBi = 0 dB (Horizontal polarization)
F/B: 18.36 dB; Rear: Azim. 120 deg, Elev. 30 deg
Freq: 28.200 MHz
Z: 45.902 - j24.244 Ohm
SWR: 1.7 (50.0 Ohm),
Elev: 10.9 deg (Real GND :10.00 m height)